

Garment Measurements

Regular Fit | Inches

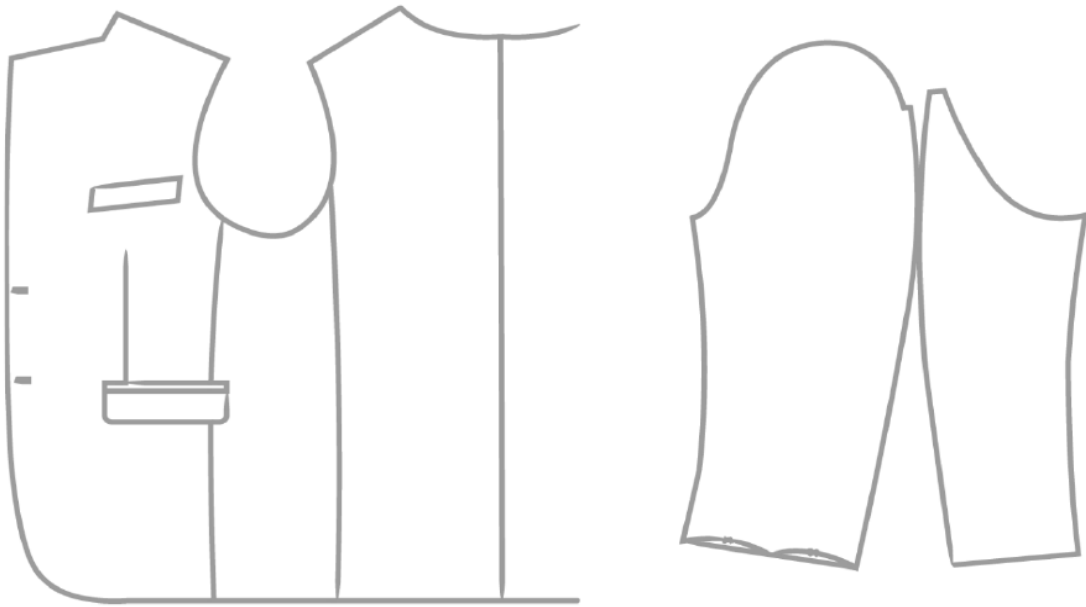

REGULAR

Suit Euro	Jacket Inch	Trousers Inch
42	34R	28R
44	35R	30R
46	37R	32R
48	38R	33R
50	40R	34R
52	42R	36R
54	43R	38R
56	44R	40R
58	46R	41R
60	48R	42R
62	50R	44R
64	51R	46R
66	52R	47R
68	54R	48R
70	55R	50R
72R	57R	52R
74R	59R	54R
76R	60R	55R
78R	62R	57R
80R	63R	59R
82R	65R	60R
84R	66R	62R
86R	68R	63R
88R	70R	64R
90R	72R	65R

LONG

Suit Euro	Jacket Inch	Trousers Inch
82	34L	28L
86	35L	29L
90	37L	32L
94	38L	33L
98	40L	34L
102	42L	36L
106	43L	38L
110	44L	40L
114	46L	41L
118	48L	42L
122	50L	44L
126	51L	46L
130	52L	47L
134	54L	48L
138	55L	50L

SHORT

Suit Euro	Jacket Inch	Trousers Inch
20	32S	28S
21	34S	30S
22	35S	32S
23	37S	33S
24	38S	34S
25	40S	36S
26	42S	38S
27	43S	40S
28	44S	41S
29	46S	42S
30	48S	44S
31	50S	46S
32	51S	47S
33	52S	48S
34	54S	50S
35	55S	52S

JACKET | REGULAR FIT | REGULAR LENGTH

	A	O	B	J	D	L	E	G	K	M
Size Euro / Inch	Back Length	Front Length	Shoulder Width	1/2 Chest	1/2 Waist	1/2 Seat	Sleeve Outside*	1/2 Upperarm	1/2 Cuff	Top Button *
42 / 34R	29 1/8	29 3/4	17 1/8	19 5/8	17 3/8	19 1/2	23 5/8	7 1/2	5 3/8	16 5/8
44 / 35R	29 1/2	30 1/4	17 1/2	20 3/8	18 1/8	20 1/4	24	7 5/8	5 1/2	16 7/8
46 / 37R	29 7/8	30 5/8	17 7/8	21 1/8	18 7/8	21	24 3/8	7 7/8	5 5/8	17 1/4
48 / 38R	30 3/8	31	18 1/4	21 7/8	19 5/8	21 3/4	24 5/8	8	5 3/4	17 1/2
50 / 40R	30 3/4	31 3/8	18 3/4	22 3/4	20 1/2	22 5/8	25	8 1/4	5 7/8	17 3/4
52 / 42R	31 1/8	31 3/4	19 1/8	23 1/2	21 1/4	23 3/8	25 3/8	8 3/8	6	18
54 / 43R	31 1/2	32 1/8	19 5/8	24 1/4	22	24 1/8	25 5/8	8 1/2	6 1/8	18 1/4
56 / 44R	31 7/8	32 1/2	20	25 1/8	22 7/8	25	26	8 3/4	6 1/8	18 5/8
58 / 46R	32 1/4	33	20 3/8	25 7/8	23 5/8	25 3/4	26 3/8	8 7/8	6 1/4	18 7/8
60 / 48R	32 5/8	33 3/8	20 7/8	26 5/8	24 3/8	26 1/2	26 3/4	9 1/8	6 3/8	19 1/8
62 / 50R	32 7/8	33 1/2	21 1/4	27 1/2	25 1/4	27 3/8	26 3/4	9 1/4	6 1/2	19 3/8
64 / 51R	33 1/8	33 3/4	21 5/8	28 1/4	26	28 1/8	27	9 1/2	6 5/8	19 5/8
66 / 52R	33 1/4	33 7/8	22 1/8	29	26 3/4	28 7/8	27 1/8	9 5/8	6 3/4	20
68 / 54R	33 1/2	34 1/8	22 1/2	29 3/4	27 1/2	29 5/8	27 1/4	9 3/4	6 7/8	20 1/4
70 / 55R	33 5/8	34 3/8	22 7/8	30 5/8	28 3/8	30 1/2	27 3/8	10	7	20 1/2
72R / 57R	33 7/8	34 1/2	23 1/4	31 3/8	29 1/8	31 1/4	27 1/2	10 1/8	7 1/8	20 3/4
74R / 59R	34	34 3/4	23 3/4	32 1/8	29 7/8	32	27 5/8	10 3/8	7 1/4	21 1/8
76R / 60R	34 1/4	34 7/8	24 1/8	33	30 3/4	32 7/8	27 3/4	10 1/2	7 3/8	21 3/8
78R / 62R	34 1/2	35 1/8	24 1/2	33 3/4	31 1/2	33 5/8	27 7/8	10 5/8	7 1/2	21 5/8
80R / 63R	34 5/8	35 3/8	25	34 1/2	32 1/4	34 3/8	28	10 7/8	7 5/8	21 7/8
82R / 65R	34 7/8	35 1/2	25 3/8	35 3/8	33 1/8	35 1/4	28 1/8	11	7 3/4	22 1/8
84R / 66R	35	35 3/4	25 3/4	36 1/8	33 7/8	36	28 1/4	11 1/8	7 7/8	22 1/2
86R / 68R	35 1/4	35 7/8	26 1/8	36 7/8	34 5/8	36 3/4	28 3/8	11 3/8	8	22 3/4
88R / 70R	35 3/8	36 1/8	26 5/8	37 5/8	35 3/8	37 1/2	28 1/2	11 1/2	8 1/8	23
90R / 72R	35 5/8	36 1/4	27	38 1/2	36 1/4	38 3/8	28 5/8	11 3/4	8 1/4	23 1/4

*** Sleeve Length Outside Adjustment Considerations**

- Soft shoulder -3mm (1/8")
- Roped shoulder +3mm
- Unconstructed shoulder -3mm
- Pleated shoulder +3mm

*** Top Button Position Adjustment Considerations**

- Coat Length Adj. = 50% Effect
- 1 Button: + 1"
- 3 Button: - 3 1/2" 2.5 Button: -1"
- DB 4/6 Button: + 1 1/8" DB 2 Btn: +2 1/4"

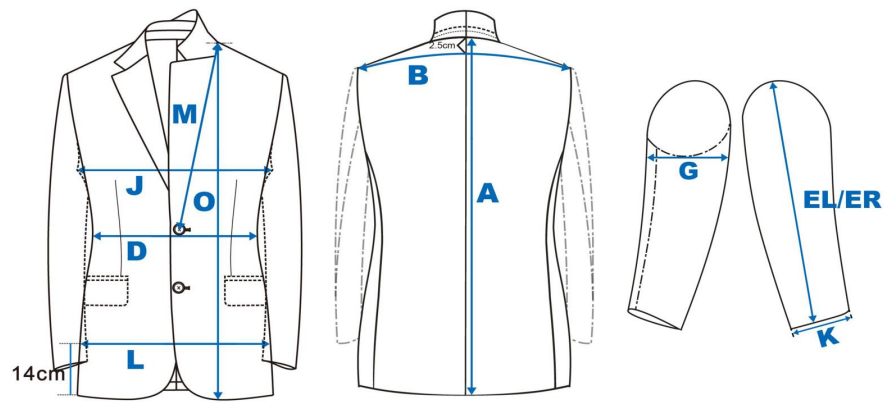

JACKET | REGULAR FIT | LONG LENGTH

Size Euro / Inch	A Back Length	O Front Length	B Shoulder Width	J 1/2 Chest	D 1/2 Waist	L 1/2 Seat	E Sleeve Outside*	G 1/2 Upperarm	K 1/2 Cuff	M Top Button *
82 / 34L	30 3/8	31	17 1/8	19 5/8	16 7/8	19	24 5/8	7 1/2	5 3/8	17
86 / 35L	30 3/4	31 3/8	17 1/2	20 3/8	17 3/4	19 7/8	25	7 5/8	5 1/2	17 3/8
90 / 37L	31 1/8	31 3/4	17 7/8	21 1/8	18 1/2	20 5/8	25 3/8	7 7/8	5 5/8	17 5/8
94 / 38L	31 1/2	32 1/8	18 1/4	21 7/8	19 1/4	21 3/8	25 5/8	8	5 3/4	17 7/8
98 / 40L	31 7/8	32 1/2	18 3/4	22 3/4	20 1/8	22 1/4	26	8 1/4	5 7/8	18 1/8
102 / 42L	32 1/4	33	19 1/8	23 1/2	20 7/8	23	26 3/8	8 3/8	6	18 3/8
106 / 43L	32 5/8	33 3/8	19 5/8	24 1/4	21 5/8	23 3/4	26 5/8	8 1/2	6 1/8	18 3/4
110 / 44L	33 1/8	33 3/4	20	25 1/8	22 1/2	24 5/8	27	8 3/4	6 1/8	19
114 / 46L	33 1/2	34 1/8	20 3/8	25 7/8	23 1/4	25 3/8	27 3/8	8 7/8	6 1/4	19 1/4
118 / 48L	33 7/8	34 1/2	20 7/8	26 5/8	24	26 1/8	27 5/8	9 1/8	6 3/8	19 1/2
122 / 50L	34	34 3/4	21 1/4	27 1/2	24 3/4	26 7/8	27 3/4	9 1/4	6 1/2	19 3/4
126 / 51L	34 1/4	34 7/8	21 5/8	28 1/4	25 5/8	27 3/4	28	9 1/2	6 5/8	20 1/8
130 / 52L	34 1/2	35 1/8	22 1/8	29	26 3/8	28 1/2	28 1/8	9 5/8	6 3/4	20 3/8
134 / 54L	34 5/8	35 3/8	22 1/2	29 3/4	27 1/8	29 1/4	28 1/4	9 3/4	6 7/8	20 5/8
138 / 55L	34 7/8	35 1/2	22 7/8	30 5/8	28	30 1/8	28 3/8	10	7	20 7/8

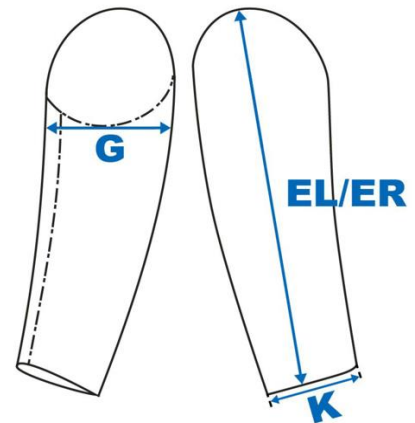
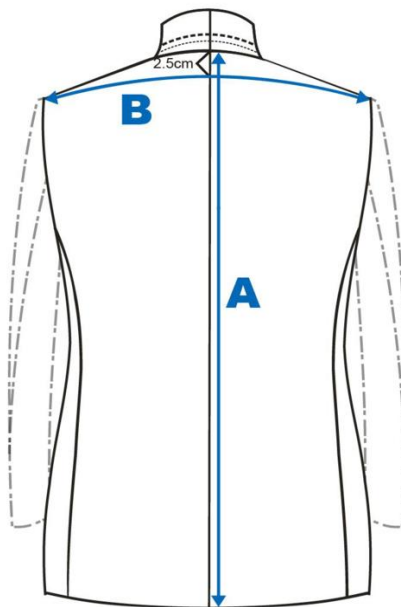
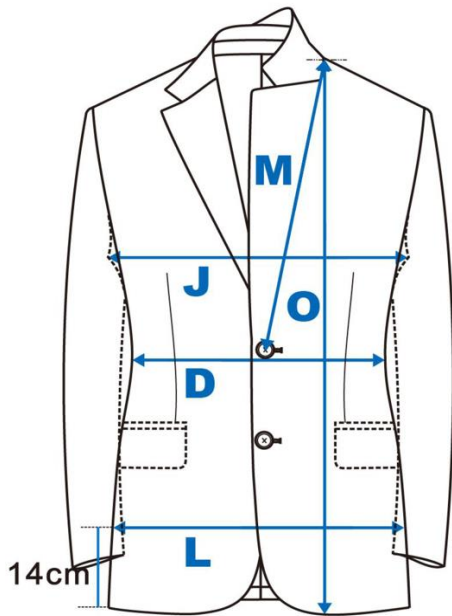

* Sleeve Length Outside Adjustment Considerations
Soft shoulder -3mm (1/8")
Roped shoulder +3mm
Unconstructed shoulder -3mm
Pleated shoulder +3mm

* Top Button Position Adjustment Considerations
Coat Length Adj. = 50% Effect
1 Button: + 1"
3 Button: - 3 1/2" 2.5 Button: -1"
DB 4/6 Button: + 1 1/8" DB 2 Btn: +2 1/4"

JACKET | REGULAR FIT | SHORT LENGTH

	A	O	B	J	D	L	E	G	K	M
Size Euro / Inch	Back Length	Front Length	Shoulder Width	1/2 Chest	1/2 Waist	1/2 Seat	Sleeve Outside*	1/2 Upperarm	1/2 Cuff	Top Button *
20 / 32S	27 1/2	28 1/4	16 5/8	18 3/4	17 3/8	19 3/8	22 3/8	7 1/4	5 1/4	16
21 / 34S	28	28 5/8	17 1/8	19 5/8	18 1/8	20 1/4	22 5/8	7 1/2	5 3/8	16 1/4
22 / 35S	28 3/8	29	17 1/2	20 3/8	18 7/8	21	23	7 5/8	5 1/2	16 1/2
23 / 37S	28 3/4	29 3/8	17 7/8	21 1/8	19 5/8	21 3/4	23 3/8	7 7/8	5 5/8	16 3/4
24 / 38S	29 1/8	29 3/4	18 1/4	21 7/8	20 1/2	22 1/2	23 3/4	8	5 3/4	17 1/8
25 / 40S	29 1/2	30 1/4	18 3/4	22 3/4	21 1/4	23 3/8	24	8 1/4	5 7/8	17 3/8
26 / 42S	29 7/8	30 5/8	19 1/8	23 1/2	22	24 1/8	24 3/8	8 3/8	6	17 5/8
27 / 43S	30 3/8	31	19 5/8	24 1/4	22 7/8	24 7/8	24 5/8	8 1/2	6 1/8	17 7/8
28 / 44S	30 3/4	31 3/8	20	25 1/8	23 5/8	25 3/4	25	8 3/4	6 1/8	18 1/4
29 / 46S	31 1/8	31 3/4	20 3/8	25 7/8	24 3/8	26 1/2	25 3/8	8 7/8	6 1/4	18 1/2
30 / 48S	31 1/2	32 1/8	20 7/8	26 5/8	25 1/4	27 1/4	25 3/4	9 1/8	6 3/8	18 3/4
31 / 50S	31 3/4	32 3/8	21 1/4	27 1/2	26	28 1/8	25 7/8	9 1/4	6 1/2	19
32 / 51S	31 7/8	32 1/2	21 5/8	28 1/4	26 3/4	28 7/8	26	9 1/2	6 5/8	19 1/4
33 / 52S	32 1/8	32 3/4	22 1/8	29	27 1/2	29 5/8	26 1/8	9 5/8	6 3/4	19 5/8
34 / 54S	32 1/4	33	22 1/2	29 3/4	28 3/8	30 3/8	26 1/4	9 3/4	6 7/8	19 7/8
35 / 55S	32 1/2	33 1/8	22 7/8	30 5/8	29 1/8	31 1/4	26 3/8	10	7	20 1/8

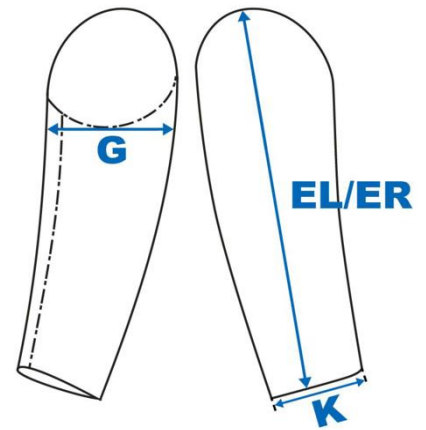
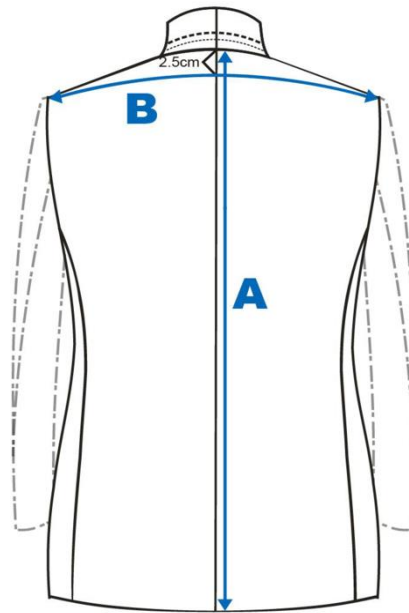
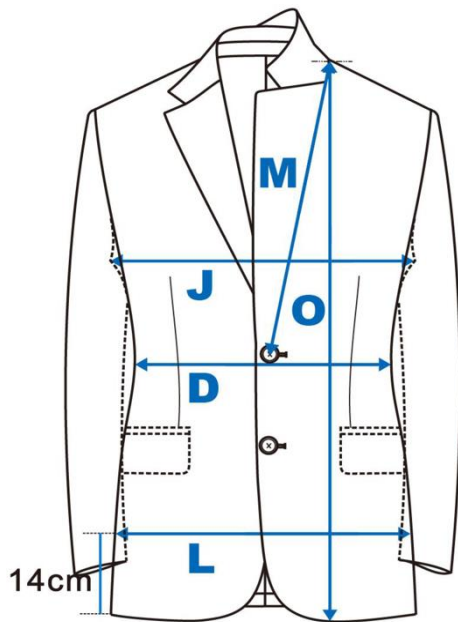

* Sleeve Length Outside Adjustment Considerations
Soft shoulder -3mm (1/8")
Roped shoulder +3mm
Unconstructed shoulder -3mm
Pleated shoulder +3mm

* Top Button Position Adjustment Considerations
Coat Length Adj. = 50% Effect
1 Button: + 1"
3 Button: - 3 1/2" 2.5 Button: -1"
DB 4/6 Button: + 1 1/8" DB 2 Btn: +2 1/4"

TROUSER | REGULAR FIT | REGULAR LENGTH

Size Euro / Inch	A	B	C	J	E	F	G	Rise (STD)
	1/2 Waist	1/2 Seat	1/2 Crotch	U-Rise	1/2 Knee	1/2 Foot	Outseam Incl. WB	
42 / 28R	14 5/8	18 1/2	12 1/2	25 3/8	8 7/8	7 5/8	39 5/8	8 7/8
44 / 30R	15 3/8	19 1/4	12 7/8	25 3/4	9 1/8	7 7/8	40 1/8	9
46 / 32R	16 1/8	20 1/8	13 1/4	26 1/8	9 3/8	8 1/8	40 5/8	9 1/8
48 / 33R	16 7/8	20 7/8	13 5/8	26 1/2	9 5/8	8 1/4	41 1/8	9 1/4
50 / 34R	17 3/4	21 5/8	14	26 7/8	9 7/8	8 1/2	41 5/8	9 3/8
52 / 36R	18 1/2	22 1/2	14 1/2	27 1/4	10 1/8	8 5/8	42 1/8	9 1/2
54 / 38R	19 1/4	23 1/4	14 7/8	27 5/8	10 3/8	8 7/8	42 5/8	9 5/8
56 / 40R	20 1/8	24	15 1/4	28 1/8	10 1/2	9	43 1/8	9 5/8
58 / 41R	20 7/8	24 3/4	15 5/8	28 1/2	10 3/4	9 1/4	43 5/8	9 3/4
60 / 42R	21 5/8	25 5/8	16	28 7/8	11	9 1/2	44 1/8	9 7/8
62 / 44R	22 1/2	26 3/8	16 3/8	29 1/4	11 1/4	9 5/8	44 1/4	10
64 / 46R	23 1/4	27 1/8	16 3/4	29 5/8	11 1/2	9 7/8	44 3/8	10 1/8
66 / 47R	24	28	17 1/4	30	11 3/4	10	44 1/2	10 1/4
68 / 48R	24 3/4	28 3/4	17 5/8	30 3/8	12	10 1/4	44 5/8	10 3/8
70 / 50R	25 5/8	29 1/2	18	30 7/8	12 1/4	10 3/8	44 3/4	10 1/2
72R / 52R	26 3/8	30 3/8	18 3/8	31 1/4	12 1/2	10 5/8	44 7/8	10 5/8
74R / 54R	27 1/8	31 1/8	18 3/4	31 5/8	12 5/8	10 7/8	45	10 3/4
76R / 55R	28	31 7/8	19 1/8	32	12 7/8	11	45 1/8	10 7/8
78R / 57R	28 3/4	32 5/8	19 5/8	32 3/8	13 1/8	11 1/4	45 1/4	11
80R / 59R	29 1/2	33 1/2	20	32 3/4	13 3/8	11 3/8	45 3/8	11 1/8
82R / 60R	30 3/8	34 1/4	20 3/8	33 1/4	13 5/8	11 5/8	45 1/2	11 1/4
84R / 62R	31 1/8	35	20 3/4	33 5/8	13 7/8	11 3/4	45 5/8	11 3/8
86R / 63R	31 7/8	35 7/8	21 1/8	34	14 1/8	12	45 3/4	11 1/2
88R / 64R	32 5/8	36 5/8	21 1/2	34 3/8	14 3/8	12 1/4	45 7/8	11 5/8
90R / 65R	33 1/2	37 3/8	21 7/8	34 3/4	14 5/8	12 3/8	46	11 3/4

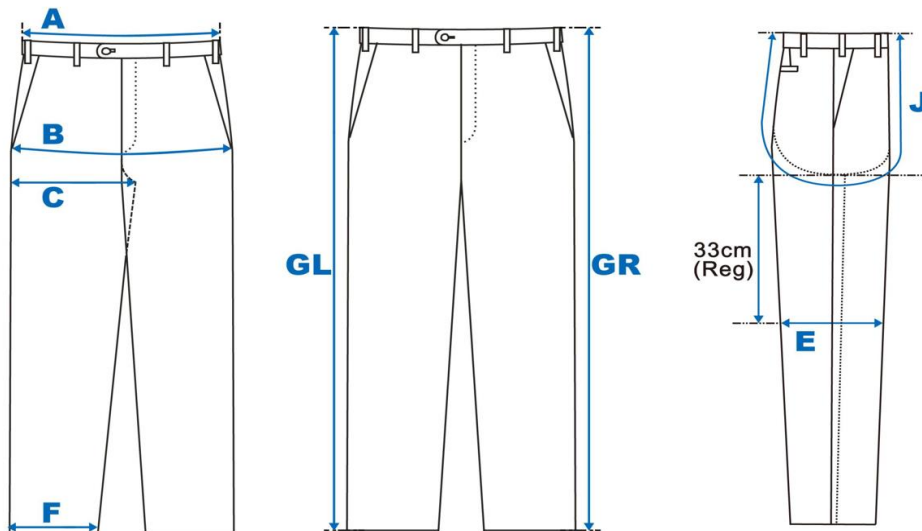

E: Knee Measurement
Size 50/34R
S: 30cm from crotch
R: 33cm from crotch
L: 35cm from crotch

TROUSER | REGULAR FIT | LONG LENGTH

Size Euro / Inch	A 1/2 Waist	B 1/2 Seat	C 1/2 Crotch	J U-Rise	E 1/2 Knee	F 1/2 Foot	G Outseam Incl. WB	Rise (STD)
82 / 28L	14 1/8	18 1/8	12 1/4	25 7/8	8 3/4	7 5/8	41 3/8	9
86 / 29L	15	18 7/8	12 5/8	26 1/4	9	7 3/4	41 7/8	9 1/8
90 / 32L	15 3/4	19 5/8	13	26 5/8	9 1/4	8	42 3/8	9 1/4
94 / 33L	16 1/2	20 1/2	13 3/8	27	9 1/2	8 1/4	42 7/8	9 3/8
98 / 34L	17 3/8	21 1/4	13 3/4	27 3/8	9 5/8	8 3/8	43 3/8	9 1/2
102 / 36L	18 1/8	22	14 1/8	27 3/4	9 7/8	8 5/8	43 7/8	9 5/8
106 / 38L	18 7/8	22 7/8	14 5/8	28 1/8	10 1/8	8 3/4	44 3/8	9 3/4
110 / 40L	19 5/8	23 5/8	15	28 1/2	10 3/8	9	44 7/8	9 7/8
114 / 41L	20 1/2	24 3/8	15 3/8	28 7/8	10 5/8	9 1/8	45 3/8	10
118 / 42L	21 1/4	25 1/4	15 3/4	29 3/8	10 7/8	9 3/8	46	10 1/8
122 / 44L	22	26	16 1/8	29 3/4	11 1/8	9 5/8	46 1/8	10 1/4
126 / 46L	22 7/8	26 3/4	16 1/2	30 1/8	11 3/8	9 3/4	46 1/8	10 3/8
130 / 47L	23 5/8	27 1/2	16 7/8	30 1/2	11 5/8	10	46 1/4	10 1/2
134 / 48L	24 3/8	28 3/8	17 3/8	30 7/8	11 3/4	10 1/8	46 3/8	10 5/8
138 / 50L	25 1/4	29 1/8	17 3/4	31 1/4	12	10 3/8	46 1/2	10 3/4

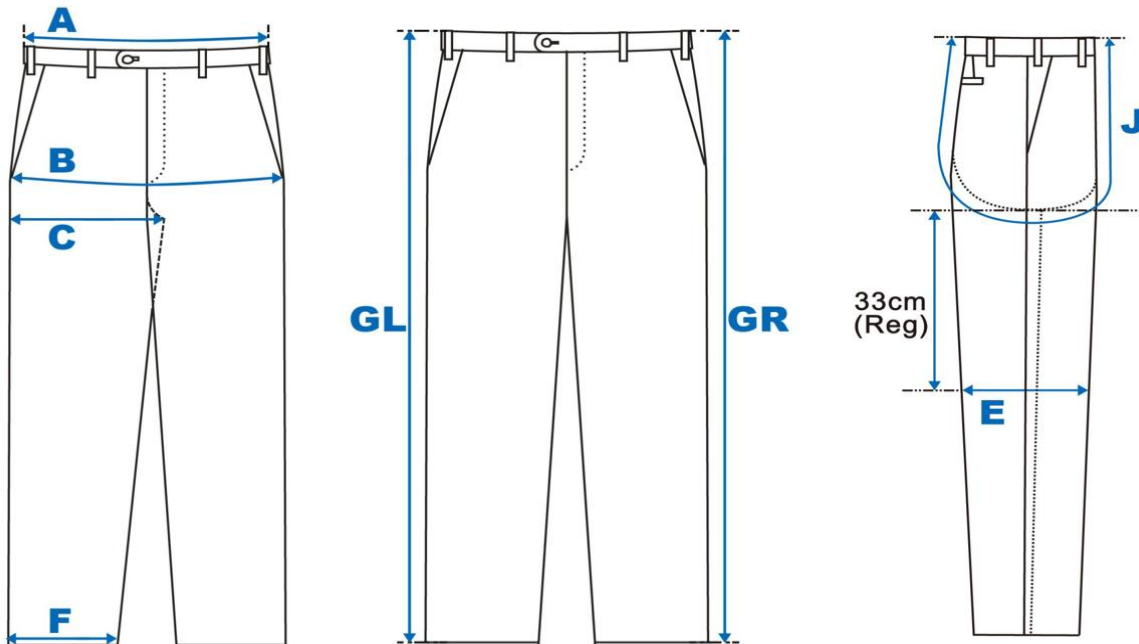

E: Knee Measurement
Size 50/34R
S: 30cm from crotch
R: 33cm from crotch
L: 35cm from crotch

TROUSER | REGULAR FIT | SHORT LENGTH

Size Euro / Inch	A	B	C	J	E	F	G	Rise (STD)
	1/2 Waist	1/2 Seat	1/2 Crotch	U-Rise	1/2 Knee	1/2 Foot	Outseam Incl. WB	
20 / 28S	14 5/8	18 3/8	12 3/8	24 5/8	8 3/4	7 5/8	37 1/4	8 1/2
21 / 30S	15 3/8	19 1/8	12 3/4	25	9	7 3/4	37 3/4	8 5/8
22 / 32S	16 1/8	20	13 1/4	25 3/8	9 1/4	8	38 1/4	8 3/4
23 / 33S	16 7/8	20 3/4	13 5/8	25 7/8	9 1/2	8 1/4	38 7/8	8 7/8
24 / 34S	17 3/4	21 1/2	14	26 1/4	9 3/4	8 3/8	39 3/8	9
25 / 36S	18 1/2	22 3/8	14 3/8	26 5/8	10	8 5/8	39 7/8	9 1/8
26 / 38S	19 1/4	23 1/8	14 3/4	27	10 1/4	8 3/4	40 3/8	9 1/4
27 / 40S	20 1/8	23 7/8	15 1/8	27 1/2	10 3/8	9	40 7/8	9 3/8
28 / 41S	20 7/8	24 5/8	15 1/2	27 7/8	10 5/8	9 1/8	41 3/8	9 1/2
29 / 42S	21 5/8	25 1/2	16	28 1/4	10 7/8	9 3/8	41 7/8	9 5/8
30 / 44S	22 1/2	26 1/4	16 3/8	28 3/4	11 1/8	9 5/8	42 3/8	9 3/4
31 / 46S	23 1/4	27	16 3/4	29 1/8	11 3/8	9 3/4	42 1/2	9 7/8
32 / 47S	24	27 7/8	17 1/8	29 1/2	11 5/8	10	42 5/8	10
33 / 48S	24 3/4	28 5/8	17 1/2	30	11 7/8	10 1/8	42 3/4	10 1/8
34 / 50S	25 5/8	29 3/8	17 7/8	30 3/8	12 1/8	10 3/8	42 7/8	10 1/4
35 / 52S	26 3/8	30 1/4	18 1/4	30 3/4	12 3/8	10 1/2	43	10 3/8

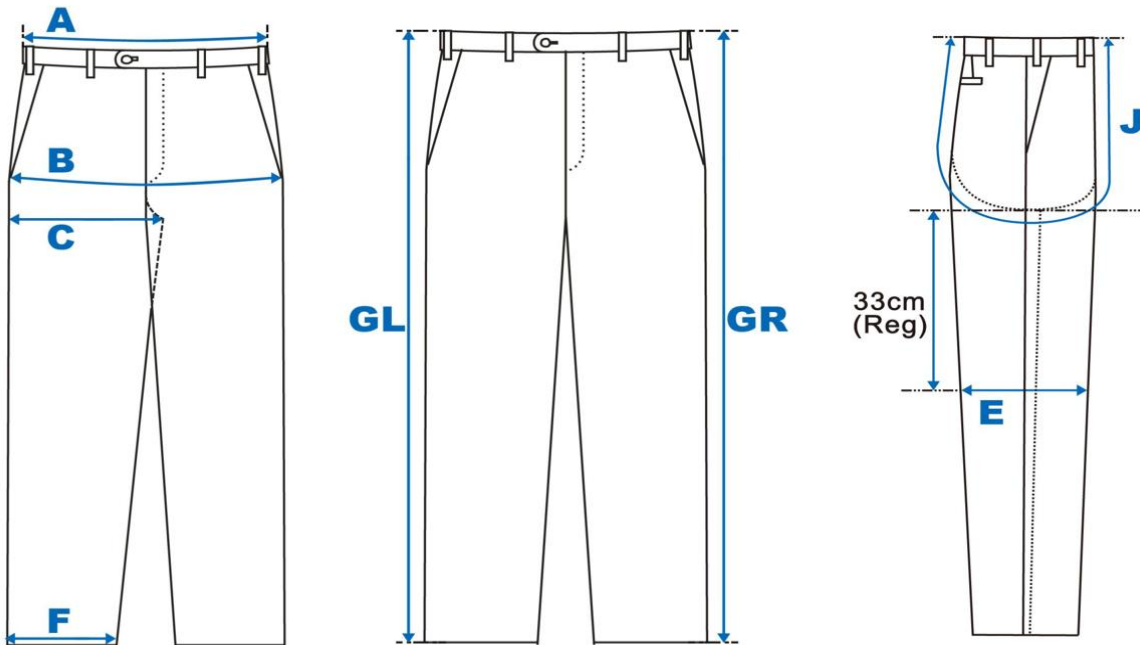

E: Knee Measurement
 Size 50/34R
 S: 30cm from crotch
 R: 33cm from crotch
 L: 35cm from crotch

WAISTCOAT | REGULAR FIT | REGULAR LENGTH

Size Euro / Inch	A	B	M	F	O
	Back Length	1/2 Waist	5B Top Button	1/2 Chest	Front Length
42 / 34R	20 7/8	16 7/8	12	17 1/2	23 1/4
44 / 35R	21 1/4	17 3/4	12 3/8	18 1/4	23 5/8
46 / 37R	21 5/8	18 1/2	12 5/8	19 1/8	24
48 / 38R	22	19 1/4	12 7/8	19 7/8	24 3/8
50 / 40R	22 1/2	20 1/8	13 1/8	20 5/8	24 3/4
52 / 42R	22 7/8	20 7/8	13 3/8	21 1/2	25 1/4
54 / 43R	23 1/4	21 5/8	13 5/8	22 1/4	25 5/8
56 / 44R	23 5/8	22 1/2	13 7/8	23	26
58 / 46R	24	23 1/4	14 1/4	23 7/8	26 3/8
60 / 48R	24 3/8	24	14 1/2	24 5/8	26 3/4
62 / 50R	24 5/8	24 3/4	14 3/4	25 3/8	27 1/8
64 / 51R	24 3/4	25 5/8	15 1/8	26 1/8	27 1/2
66 / 52R	25	26 3/8	15 3/8	27	28
68 / 54R	25 1/4	27 1/8	15 5/8	27 3/4	28 3/8
70 / 55R	25 3/8	28	16	28 1/2	28 3/4
72R / 57R	25 5/8	28 3/4	16 1/4	29 3/8	29 1/8
74R / 59R	25 3/4	29 1/2	16 1/2	30 1/8	29 1/2
76R / 60R	26	30 3/8	16 3/4	30 7/8	29 7/8
78R / 62R	26 1/8	31 1/8	17 1/8	31 3/4	30 3/8
80R / 63R	26 3/8	31 7/8	17 3/8	32 1/2	30 3/4
82R / 65R	26 5/8	32 5/8	17 5/8	33 1/4	31 1/8
84R / 66R	26 3/4	33 1/2	17 7/8	34	31 1/2
86R / 68R	27	34 1/4	18 1/4	34 7/8	31 7/8
88R / 70R	27 1/8	35	18 1/2	35 5/8	32 1/4
90R / 72R	27 3/8	35 7/8	18 3/4	36 3/8	32 5/8

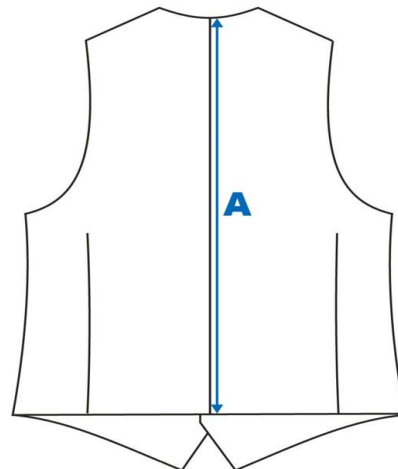
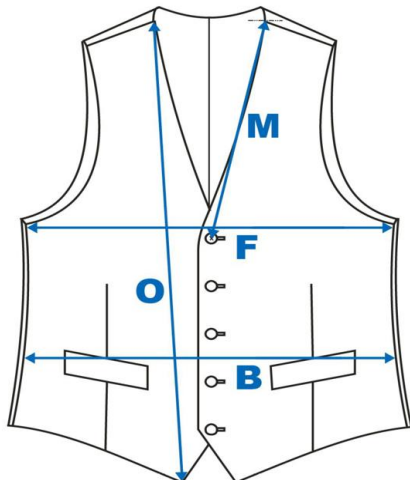

WAISTCOAT | REGULAR FIT | LONG LENGTH

Size Euro / Inch	A Back Length	B 1/2 Waist	M 5B Top Button	F 1/2 Chest	O Front Length
82 / 34L	22	16 1/2	12	17 1/8	24 3/8
86 / 35L	22 1/2	17 3/8	12 3/8	17 7/8	24 3/4
90 / 37L	22 7/8	18 1/8	12 5/8	18 3/4	25 1/4
94 / 38L	23 1/4	18 7/8	12 7/8	19 1/2	25 5/8
98 / 40L	23 5/8	19 5/8	13 1/8	20 1/4	26
102 / 42L	24	20 1/2	13 3/8	21 1/8	26 3/8
106 / 43L	24 3/8	21 1/4	13 5/8	21 7/8	26 3/4
110 / 44L	24 3/4	22	13 7/8	22 5/8	27 1/8
114 / 46L	25 1/4	22 7/8	14 1/4	23 3/8	27 1/2
118 / 48L	25 5/8	23 5/8	14 1/2	24 1/4	28
122 / 50L	25 3/4	24 3/8	14 3/4	25	28 3/8
126 / 51L	26	25 1/4	15 1/8	25 3/4	28 3/4
130 / 52L	26 1/8	26	15 3/8	26 5/8	29 1/8
134 / 54L	26 3/8	26 3/4	15 5/8	27 3/8	29 1/2
138 / 55L	26 5/8	27 1/2	16	28 1/8	29 7/8

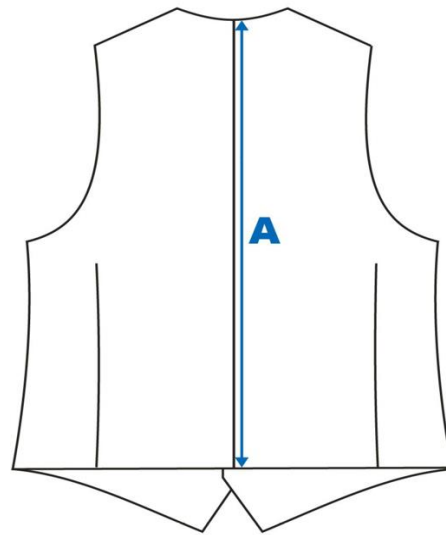
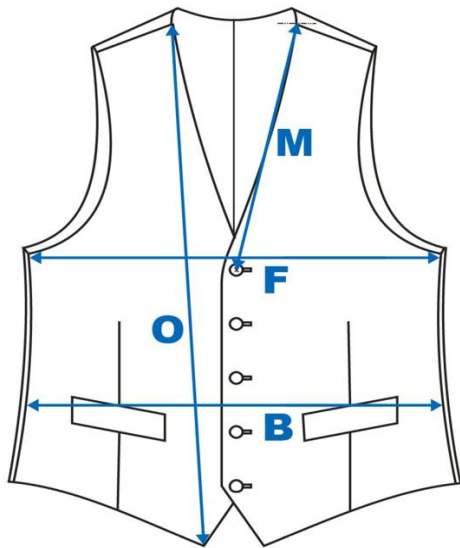

WAISTCOAT | REGULAR FIT | SHORT LENGTH

	A	B	M	F	O
Size Euro / Inch	Back Length	1/2 Waist	5B Top Button	1/2 Chest	Front Length
20 / 32S	19 1/4	16 7/8	11 3/4	17 1/2	21 5/8
21 / 34S	19 5/8	17 3/4	12	18 1/4	22
22 / 35S	20 1/8	18 1/2	12 3/8	19 1/8	22 1/2
23 / 37S	20 1/2	19 1/4	12 5/8	19 7/8	22 7/8
24 / 38S	20 7/8	20 1/8	12 7/8	20 5/8	23 1/4
25 / 40S	21 1/4	20 7/8	13 1/8	21 1/2	23 5/8
26 / 42S	21 5/8	21 5/8	13 3/8	22 1/4	24
27 / 43S	22	22 1/2	13 5/8	23	24 3/8
28 / 44S	22 1/2	23 1/4	13 7/8	23 7/8	24 3/4
29 / 46S	22 7/8	24	14 1/4	24 5/8	25 1/4
30 / 48S	23 1/4	24 3/4	14 1/2	25 3/8	25 5/8
31 / 50S	23 3/8	25 5/8	14 3/4	26 1/8	26
32 / 51S	23 5/8	26 3/8	15 1/8	27	26 3/8
33 / 52S	23 7/8	27 1/8	15 3/8	27 3/4	26 3/4
34 / 54S	24	28	15 5/8	28 1/2	27 1/8
35 / 55S	24 1/4	28 3/4	16	29 3/8	27 1/2

